



US Army Corps  
of Engineers®



# Introduction

The three most important practices in accomplishing a job are SAFETY, SAFETY, and SAFETY. Be sure to check the inside of the house for structural damage such as missing columns and walls.

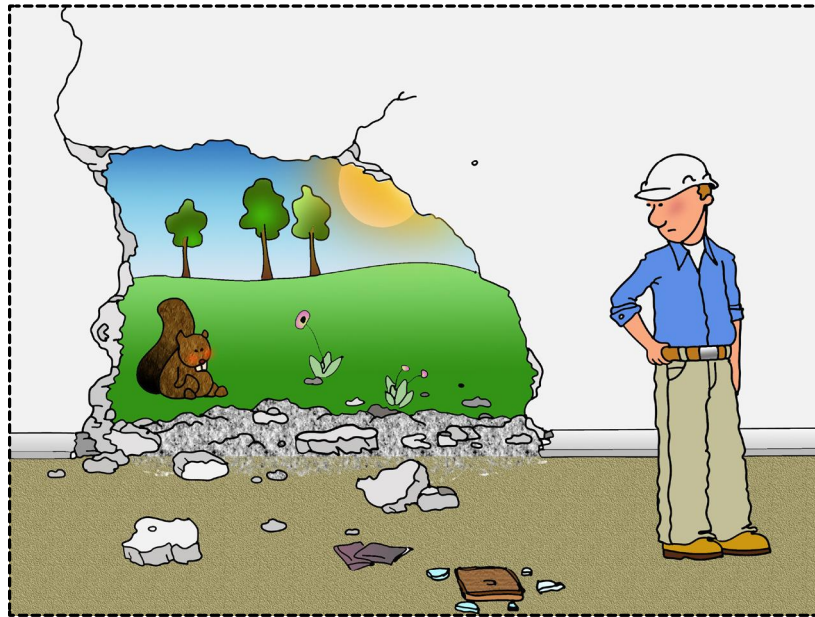

Wear appropriate safety attire:

- Hard hat
- Safety glasses
- Long pants
- Closed-toe rubber-soled shoes

Safety glasses

Hard hat



Long pants

Closed-toe rubber-soled shoes

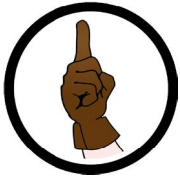

The installation of a temporary tarp does not guarantee that the roof will be watertight. The intent is to reduce the potential for further water damage.

Use a safe ladder and lean it against the house at a safe angle, making sure the ladder extends three feet above the edge of the roof. Tie down the ladder to the edge of the roof and/or brace the feet to avoid slipping.



Inspect the roof to make sure all debris is cleared and be careful to avoid any holes in the roof. Do not attempt to cover the roof during wet conditions.

Take care to ensure the adequate strength and structural soundness of the existing joists and planking.

If you encounter asbestos roofing materials, take special precautions to remove the roofing materials and temporarily cover the roof. It is recommended that you hire a licensed asbestos roofing contractor to remove any asbestos material and install the temporary roof.

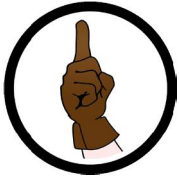

When on the roof, do not walk on wet particle board, as it can lose its strength when wet.



Cosmetic damage to a building such as missing wall plaster, broken windows, and missing aluminum siding will not necessarily make the building unsafe for walking on the roof.

Finally, for good practice, do not install plastic on the roof when occupants are inside, even if the house is structurally safe. Hammering can cause loosened ceiling plaster to fall.



# Installing Tarp on a Shingle Asphalt Roof

## Step 1

Place wooden furring strips lengthwise along a piece of tarp.

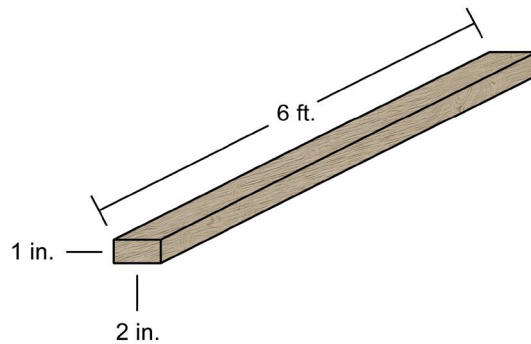

Each furring strip is 6 feet (1.8 m) in length, so if you are covering a small area of damage, one strip may suffice. If you are covering a large area, you may need to abut two or more strips until you have a long enough length of wood.

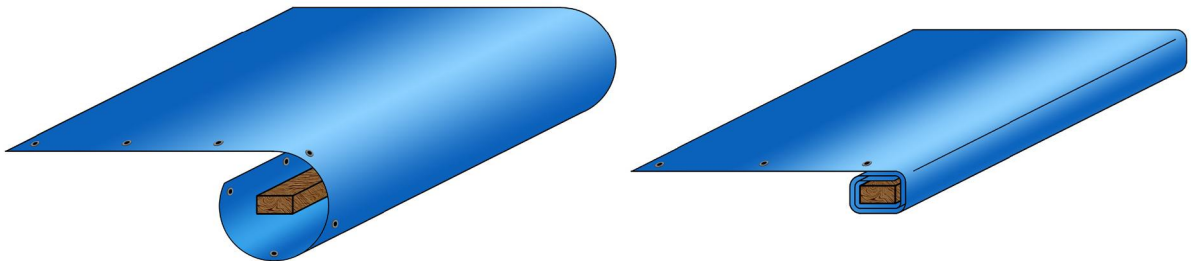

Allow approximately 2 feet (60 cm) of tarp to wrap around the furring strips, so that you have three or four tightly wound layers.

Be sure that you do an "overhand roll" on these furring strips so that the length of tarp extends from the top, not the bottom.



## Step 2

Nail the first furring strips (wrapped in tarp) to the shingles 2 feet (60 cm) below the damaged area on the slope of the roof.

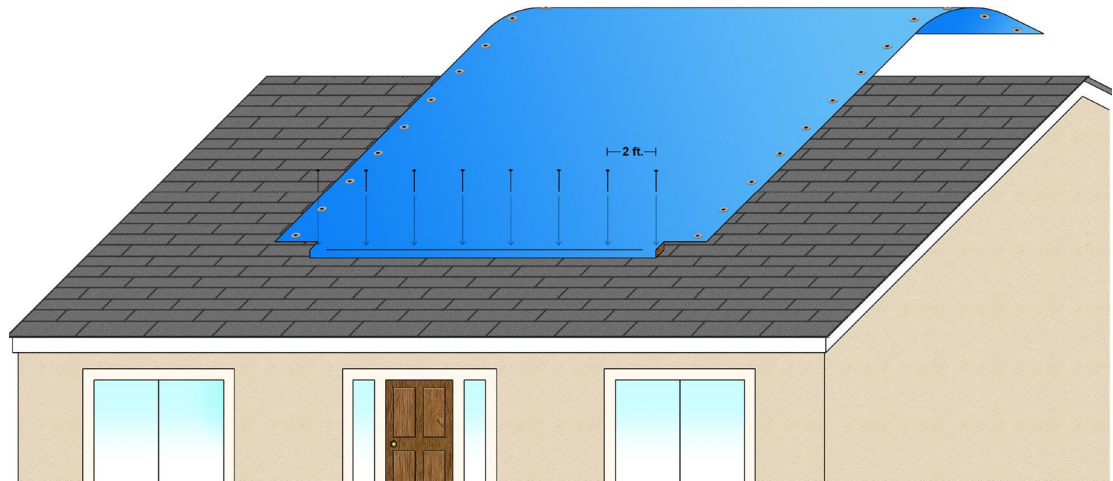

To prevent rust stains, use 8d common galvanized steel nails, and space them 2 feet (60 cm) apart on center.

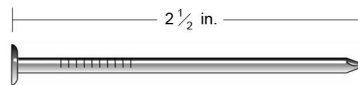

If possible, extend the tarp 4 feet (1.2 m) beyond the damaged area on either side to apply additional furring strips and prevent leaks.



## Step 3

Now stretch the tarp across the damaged area toward the ridge cap of the roof and cut it to fit, allowing at least 4 extra feet (1.2 m) of tarp to overhang the ridge cap.

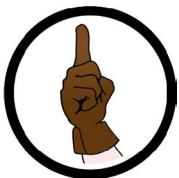
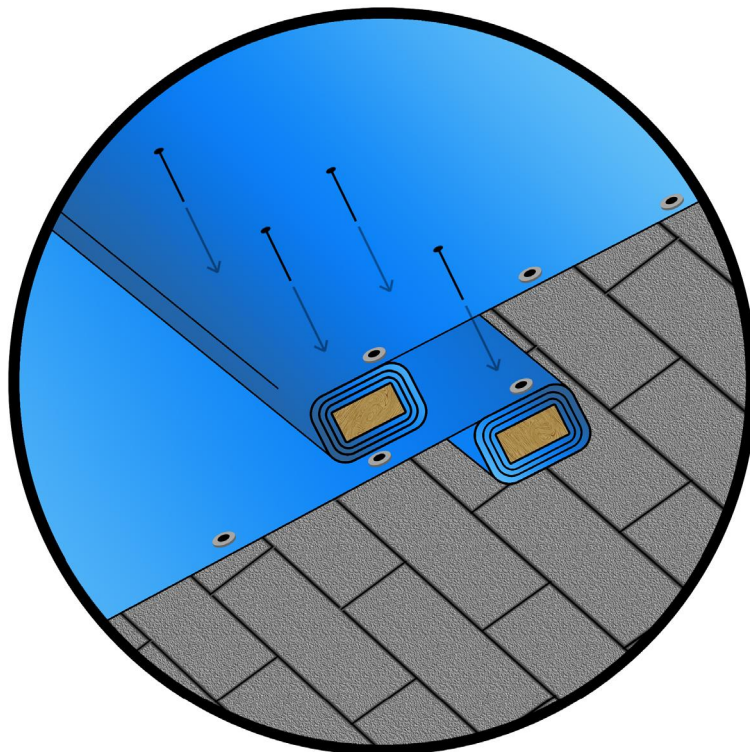

If the tarp is not long enough to reach over the ridge cap, you will need to install an overlapping piece of tarp above the first piece. Use the top 2 feet (60 cm) of tarp to overhand roll furring strips and nail them to the shingles or plywood. Now roll furring strips in a second piece of tarp and nail the strips on top of the first piece of tarp, just below the top row of furring strips. Pull this second piece of tarp over the ridge cap.



## Step 4

If you encounter roof penetrations such as plumbing pipes or exhaust vents, cut an "X" in the plastic to fit over the object. Use roofing tape to adhere the tarp to the base of the object and seal the "X." Make sure the seal is watertight and the tape extends 2 inches (5 cm) onto the base of the penetration.

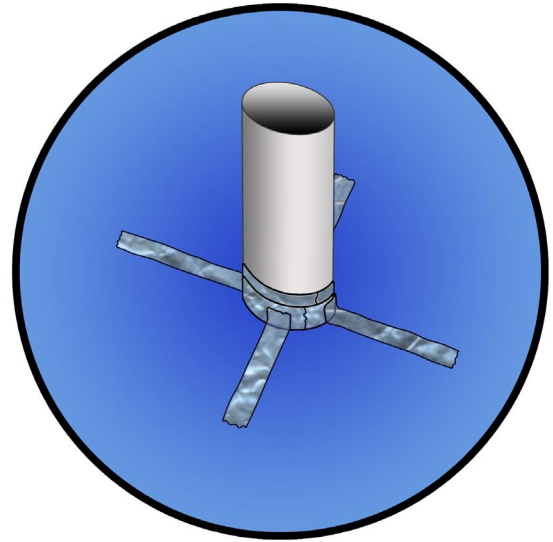
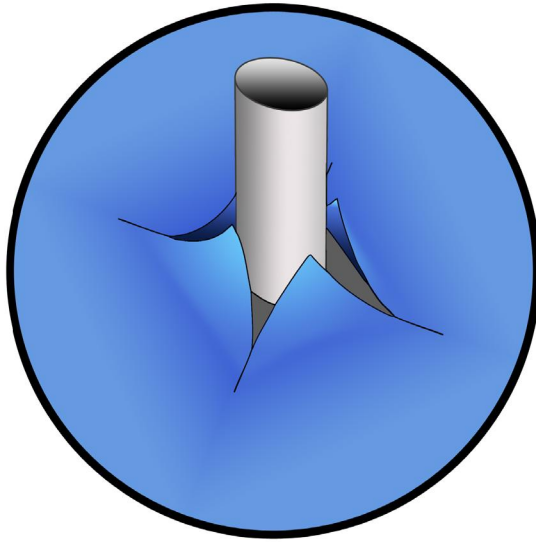

Butyl rubber roofing adhesive is the standard tape for temporary roofing operations. If you cannot find it, you may use aluminum foil tape. Any tape you use should be 2 mm thick, weather-resistant, and functional in temperatures ranging from  $-35^{\circ}$  to  $108^{\circ}$  F ( $-37^{\circ}$  to  $42^{\circ}$  C).



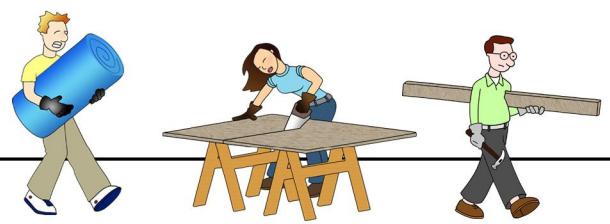

## Step 5

Use the overhanging tarp at the ridge cap of the roof to apply additional furring strips on the abutting slope. Wrap the strips using the same overhand roll method detailed in Step 1 and nail it to the shingles. The tarp should be pulled taut over the ridge cap to prevent wind and rain from getting under it. Remember to space the nails no more than 2 feet (60 cm) apart on center.

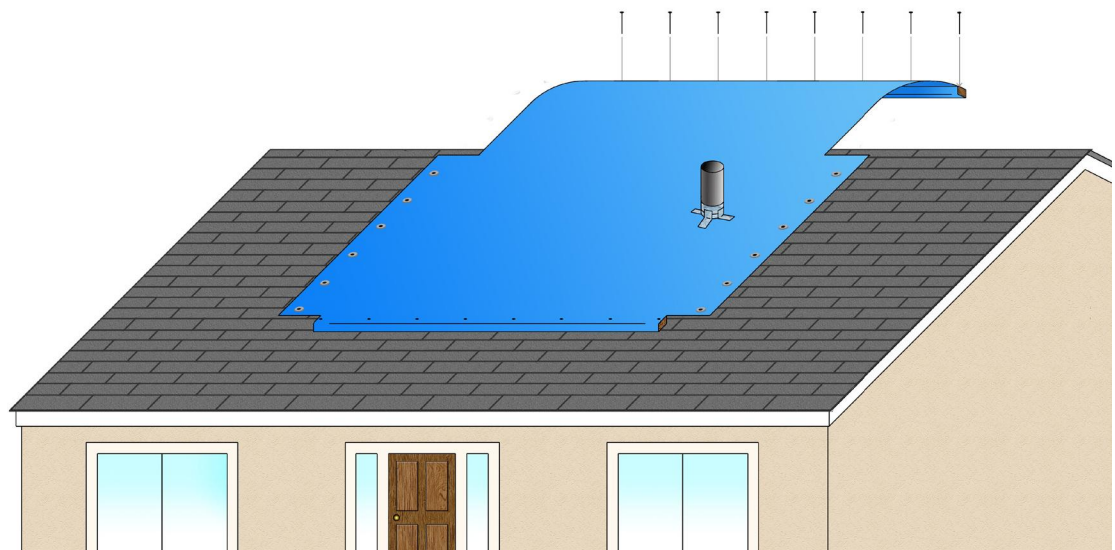
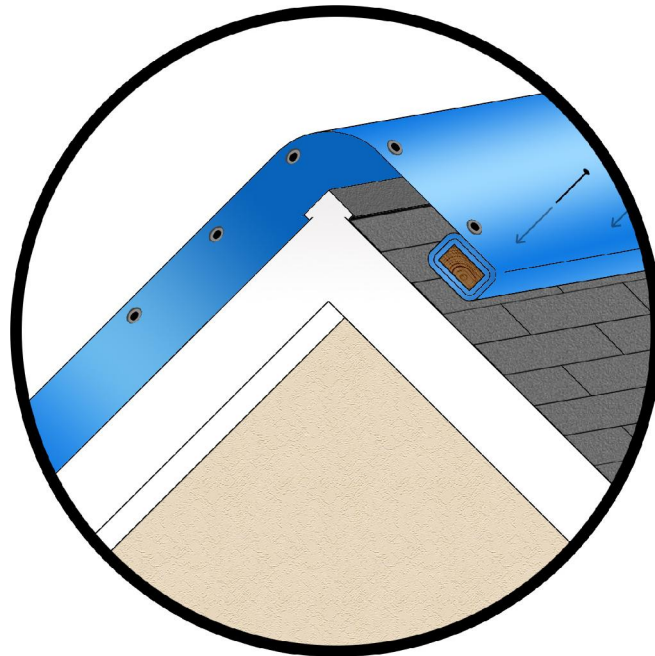



## Step 6

Use 2 feet (60 cm) of tarp on the right side to wrap furring strips. Do an overhand roll and wrap the wood three or four times with plastic. Nail these furring strips into the shingles, ensuring that they are no less than two feet from the damaged area of the roof.

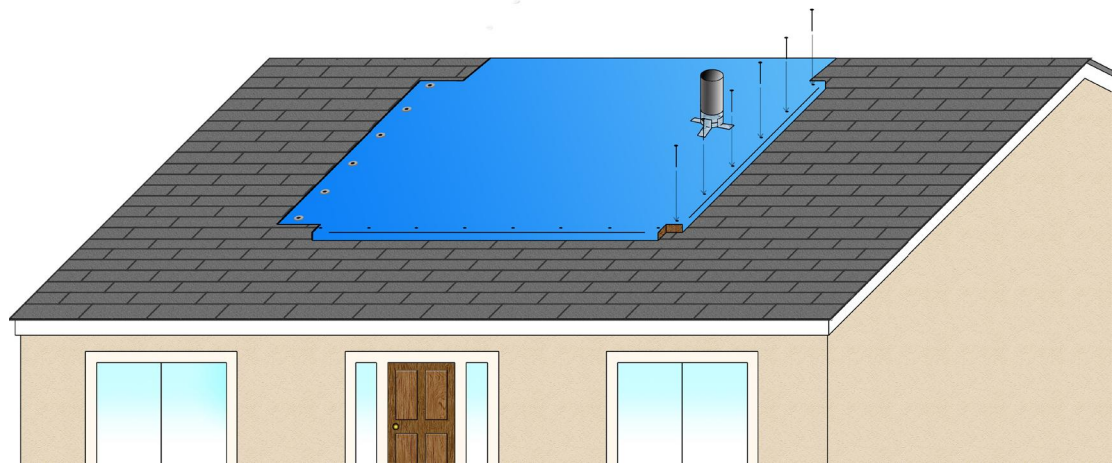

If the section of repair is large, it may be a good idea to use fluorescent spray paint to mark an "X" over the damaged area.

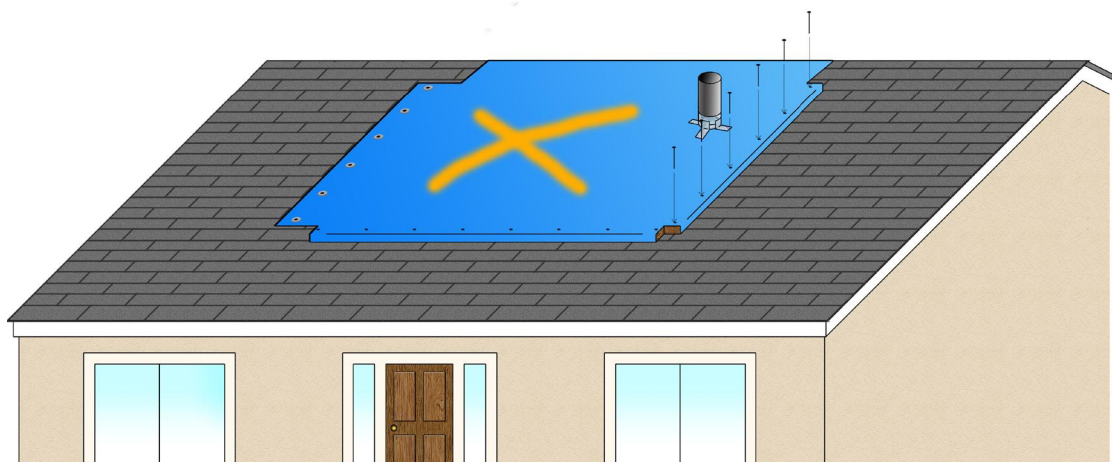



## Step 7

Now use the extra 4 feet (1.2 m) of tarp to the left of the damaged area to apply furring strips. Perform an overhand roll and wrap the furring strips tightly. Nail the strips to the edge of the roof.

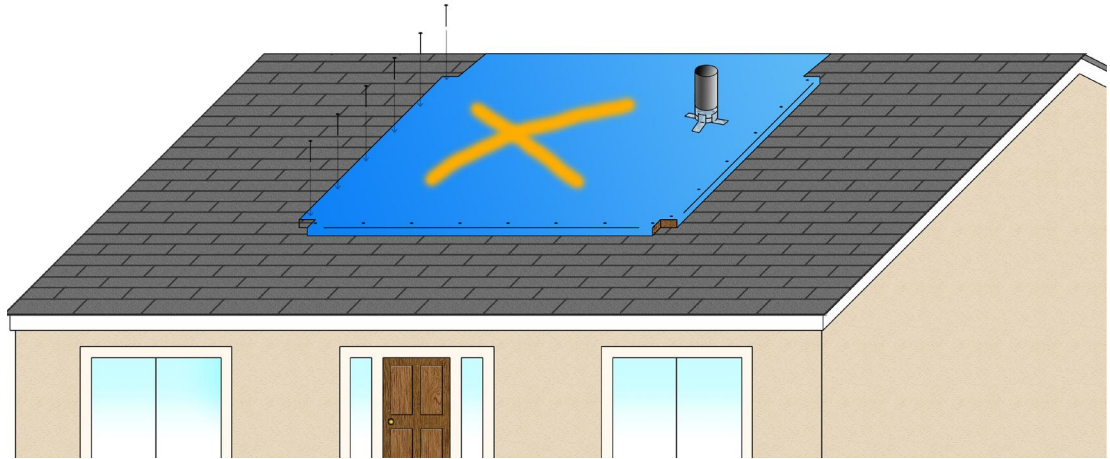

## Step 8

Nail furring strips over the tarp on each slope of the roof so that there is no more than 6 feet (1.8 m) of space between any two furring strips. If possible, try to nail these furring strips into rafters. **NOTE: These strips will be the only ones not wrapped in tarp.**

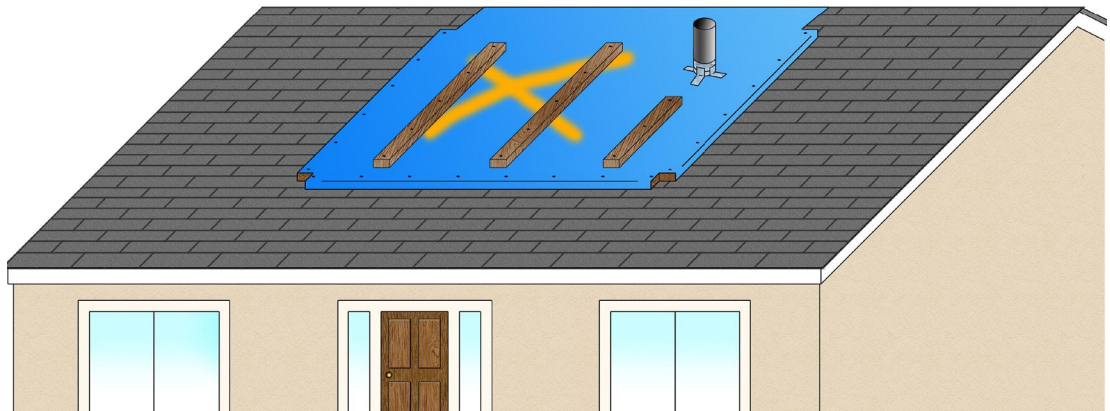

### FINAL CHECKS:

Make sure all holes, cuts, and tears in the tarp are sealed with roofing tape. Ensure that all furring strips are firmly secured to the top of the roof and that wind or rain cannot get under the plastic.

# Installing Tarp on a Metal/Tin Roof

Nailing or screwing furring strips to the top of any metal roof will permanently damage the roofing surface beyond the area of the tarp; it is only recommended for areas where the metal roof is missing or where it is severely damaged.

Before beginning the tarp installation process, all damaged metal should be hammered down or cut off. Any protruding metal will destroy a temporary tarp roof.

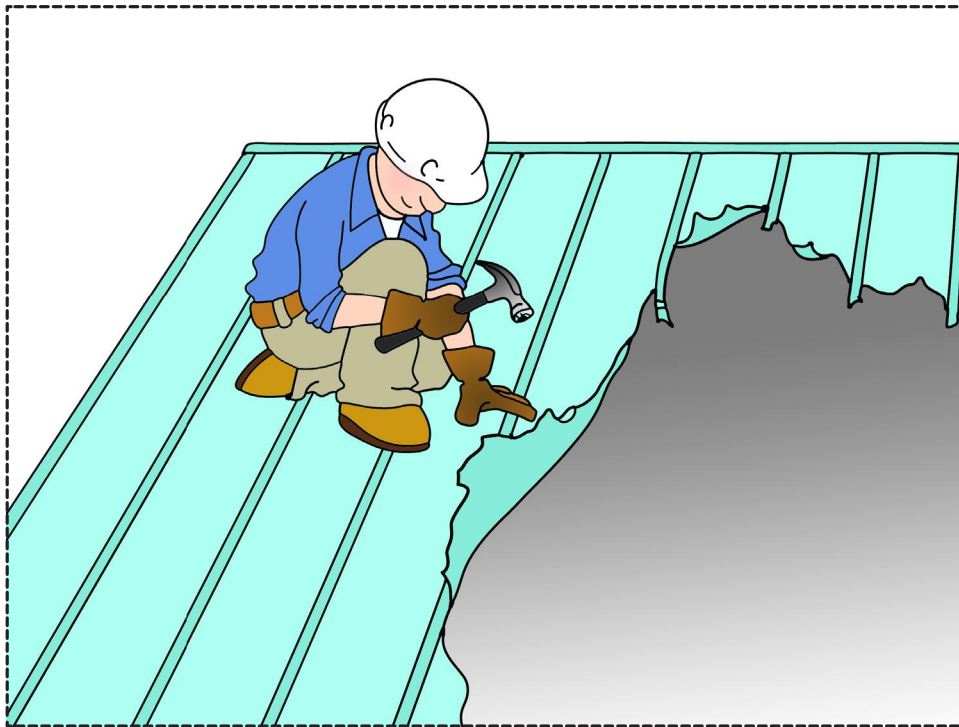



# Step 1

Place wooden furring strips lengthwise along a strip of tarp.

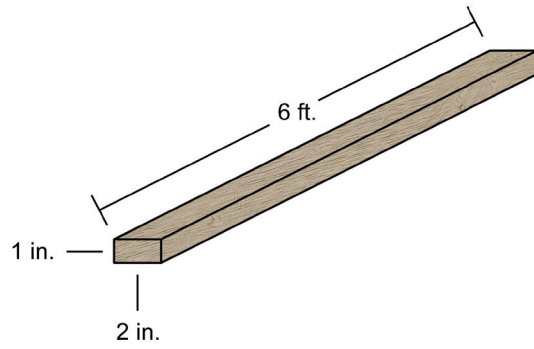

Each furring strip is 6 feet (1.8 m) in length, so if you are covering a small area of damage, one strip may suffice. If you are covering a large area, you may need to abut two or more strips until you have a long enough length of wood.

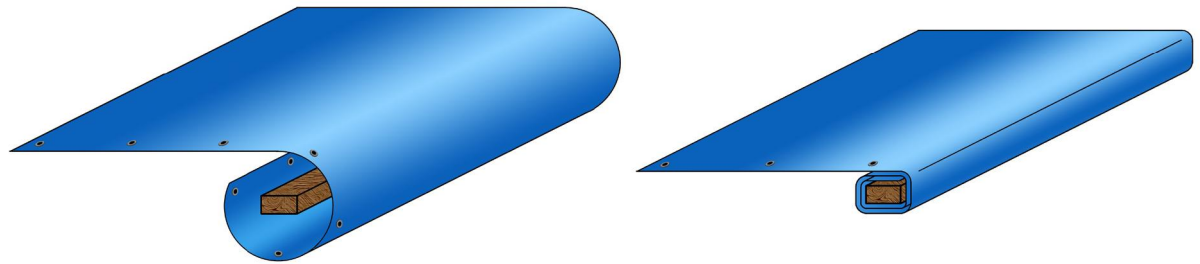

Allow approximately 2 feet (60 cm) of tarp to wrap around the furring strips, so that you have three or four tightly wound layers. Be sure that you do an "overhand roll" on these furring strips so that the length of tarp extends from the top, not the bottom.



## Step 2

Screw the first furring strips (wrapped in tarp) to the side wall of the home (not to the metal roof).

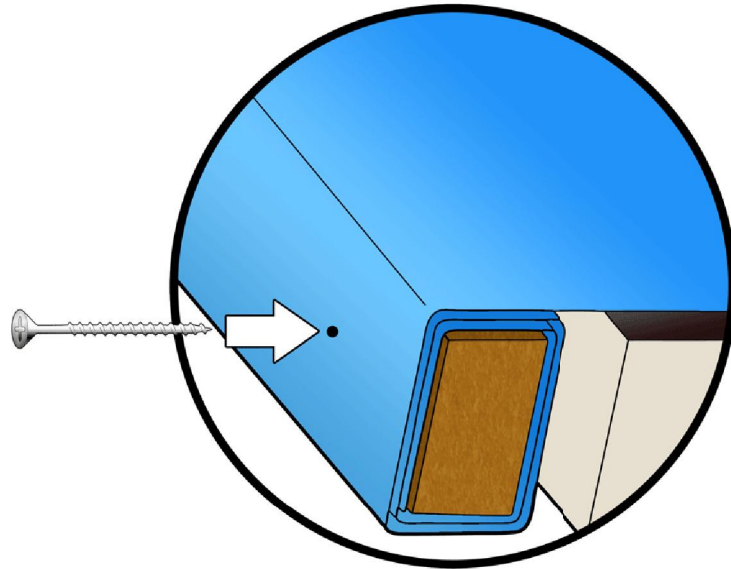

Use 2 ½-inch galvanized #10 screws, and space them 2 feet (60 cm) apart on center.

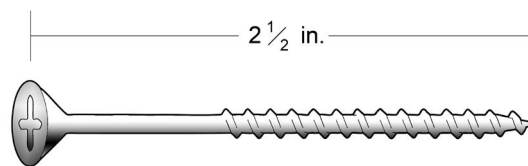

If you must secure the furring strips directly to the metal roof, screw them into joists or rafters. Find the existing fasteners already in the roof and try to screw the furring strips inline with these.



# Step 3

If you are using parachute cords to secure the tarp, thread the cords through the grommets in the tarp and pull it taut.

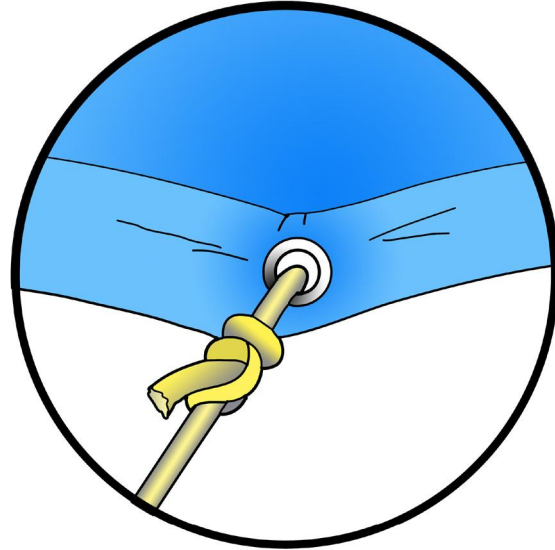

Now anchor the cords to the ground with tent stakes or other suitable securing devices.

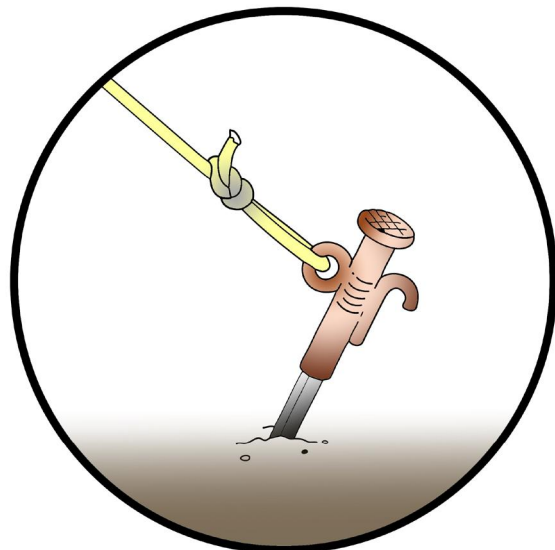



## Step 4

For added security, install cords across the tarp between each pair of grommets and attach these to stakes or securing devices in the ground. This will reduce the size of the gaps between the metal roof and the tarp.

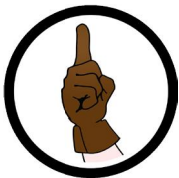
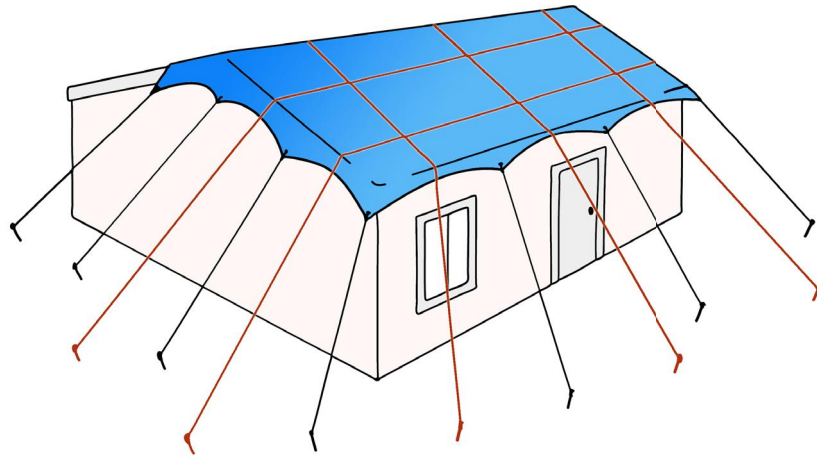

This method is not 100 percent secure. You should check the cords every few days to ensure they are tight and, if necessary, tighten or reattach the cords to the stakes.

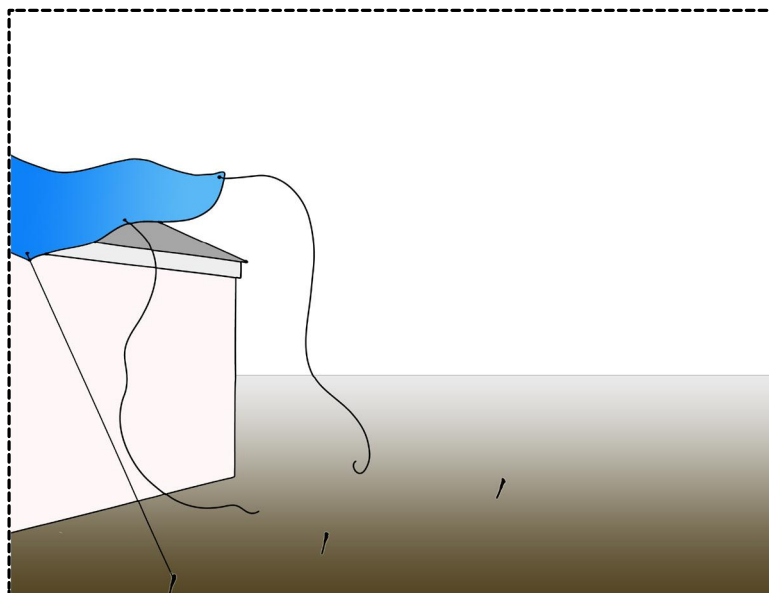



# Installing Tarp on a Tile Roof

Tile roofs are inherently slippery. Pay careful attention to damaged areas of the roof, as broken tile pieces will increase the risk of a fall.

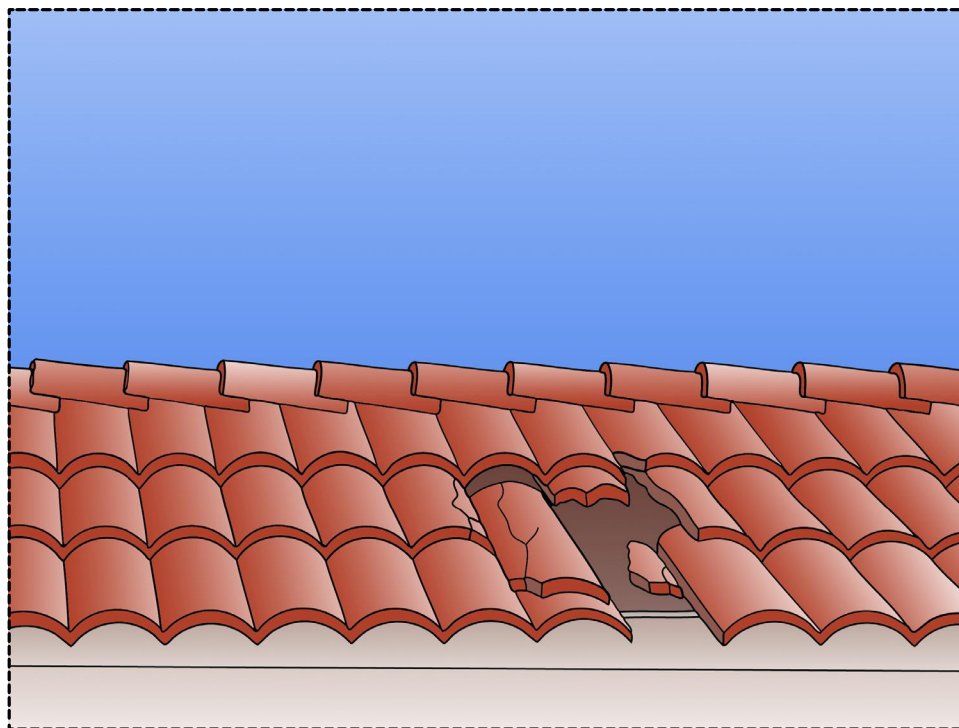

Installation of a temporary tarp roof can prove difficult and dangerous.



## Step 1

If you are using parachute cords to secure the tarp, thread the cords through the grommets in the tarp and pull it taut.

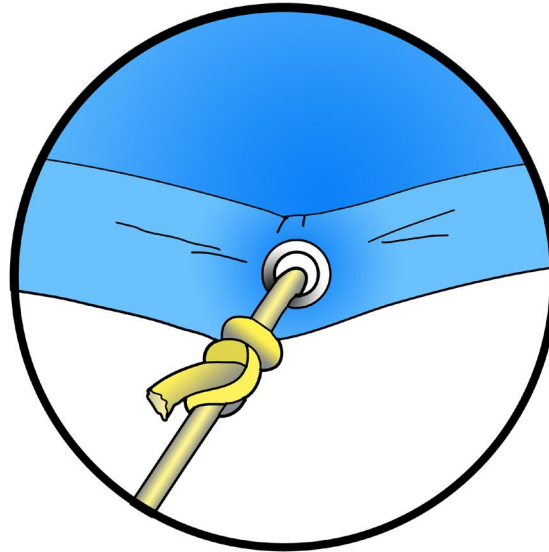

Now anchor the cords to the ground with tent stakes or other suitable securing devices.

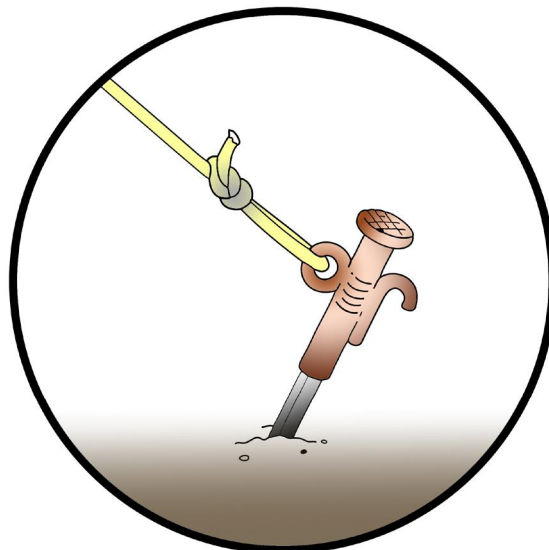

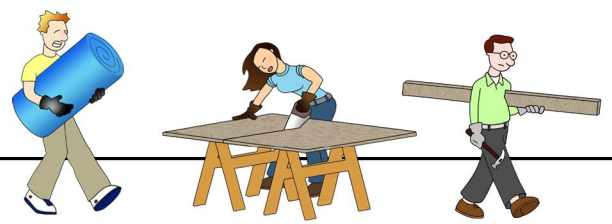

## Step 2

For added security, install cords across the tarp between each pair of grommets and attach these to stakes or securing devices in the ground. This will reduce the size of the gaps between the tile roof and the tarp.

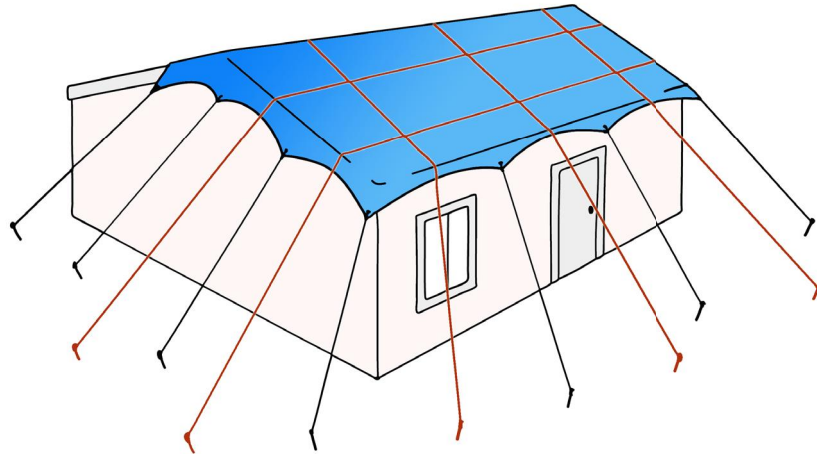

This method is not 100 percent secure. You should check the cords every few days to ensure they are tight and, if necessary, tighten or reattach the cords to the stakes.

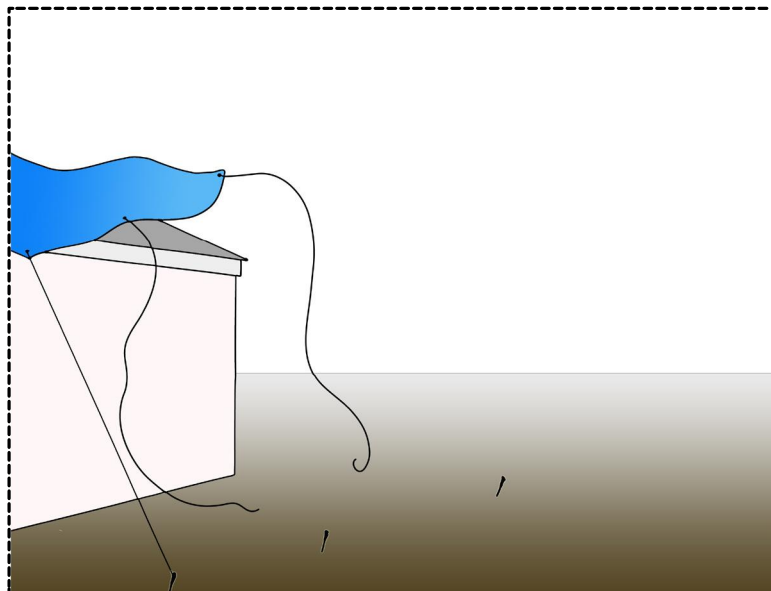



The temporary roof installation is complete.

